



# ***Maintenance Manual - Telehandlers***

***GTH-636***  
***GTH-844***  
***GTH-1056***  
***GTH-1256***  
***GTH-1544***  
***GTH-5519***

Refer to the inside cover for a list of models included in this manual.

This manual includes detailed procedures for each maintenance inspection.

For Repair procedures, Fault Codes, Electrical and Hydraulic Schematics, refer to the appropriate Service and Repair Manual for your machine.

Part No. 1272858  
Rev A1  
September 2016

---

# Introduction

---

## Important

Read, understand and obey the safety rules and operating instructions in the appropriate Operator's Manual on your machine before attempting any maintenance procedure.

This manual provides detailed scheduled maintenance information for the machine owner and user.

Basic mechanical, hydraulic and electrical skills are required to perform most procedures. However, several procedures require specialized skills, tools, lifting equipment and a suitable workshop. In these instances, we strongly recommend that maintenance be performed at an authorized Genie dealer service center.

---

## Compliance

### Machine Design Life

Unrestricted with proper operation, inspection and scheduled maintenance.

---

## Technical Publications

Genie has endeavored to deliver the highest degree of accuracy possible. However, continuous improvement of our products is a Genie policy. Therefore, product specifications are subject to change without notice.

Readers are encouraged to notify Genie of errors and send in suggestions for improvement. All communications will be carefully considered for future printings of this and all other manuals.

---

## Contact Us:

Internet: [www.genielift.com](http://www.genielift.com)  
E-mail: [awp.techpub@terex.com](mailto:awp.techpub@terex.com)

---

Copyright © 2016 by Terex Corporation

1272858 Rev A, March 2016

First Edition, First Printing

Genie is a registered trademark of Terex South Dakota, Inc. in the U.S.A. and many other countries.

"GTH" is a trademark of Terex South Dakota, Inc.

## Introduction

### Models included in this manual

Use the following chart to identify the specific serial number for models included in this manual.

Models	Serial number
GTH-636	from GTH0615H-10001 to 16H-10742 from GTH0615E-10000 to GTH0616E-10999 from GTH06E-11000
GTH-844	from GTH0813-16606 to GTH0816-21572 from GTH0816E-10000 to GTH0816E-10699 from GTH08E-10700
GTH-1056	from GTH1010-14001 to GTH1014-20404 from GTH1014E-10001 to GTH1016E-10799 from GTH10E-10800
GTH-1256	from GTH1215M-101 to GTH1216M-249 from GTH12M-250
GTH-1544	from GTH1513B-1 to 15B-339 (includes 24273)
GTH-5519	from GTH5514B-101 to GTH5516B-4411 from GTH5516M-4411 to GTH5516M-5799 from GTH55M-5800

### Identifying the Correct Procedure for your Model

Unless otherwise noted, each procedure will apply to all models. Procedures that only apply to specific models or options will include the information in the procedure title.

Examples of procedures that apply to specific models:

- Adjust the Boom Sequencing Chains - **GTH-636 and GTH-844**
- Adjust the Boom Sequencing Chains - **GTH-1056**

Examples of procedures that apply to all models:

- Inspect the Electrical Wiring
- Inspect the Tires, Wheels and Lug Nut Torque

### Find additional Manuals for your Model

Go to <http://www.genielift.com>

Use the links to locate Service Manuals, Maintenance Manuals, Service and Repair Manuals, Parts Manuals and Operator's Manuals.

# Introduction

## Revision History

Revision	Date	Section	Procedure / Description
A	3/2016		Initial Release
A1	9/2016	Introduction	Models Included
<b>Reference Examples:</b>			
Section – Specifications			<b>Electronic Version</b> Click on any content or procedure in the Table of Contents to view the update.
Section – Maintenance, (procedure)			

# Introduction

## Revision History (continued)

Revision	Date	Section	Procedure / Description
<b>Reference Examples:</b>			
Section – Specifications			<b>Electronic Version</b> Click on any content or procedure in the Table of Contents to view the update.
Section – Maintenance, (procedure)			



---

# Safety Rules



## Danger

Failure to obey the instructions and safety rules in this manual and the appropriate Operator's Manual on your machine will result in death or serious injury.

Many of the hazards identified in the operator's manual are also safety hazards when maintenance and repair procedures are performed.

## Do Not Perform Maintenance Unless:

- You are trained and qualified to perform maintenance on this machine.
- You read, understand and obey:
  - manufacturer's instructions and safety rules
  - employer's safety rules and worksite regulations
  - applicable governmental regulations
- You have the appropriate tools, lifting equipment and a suitable workshop.

# Safety Rules

## Personal Safety

Any person working on or around a machine must be aware of all known safety hazards. Personal safety and the continued safe operation of the machine should be your top priority.



Read each procedure thoroughly. This manual and the decals on the machine, use signal words to identify the following:



Safety alert symbol—used to alert personnel to potential personal injury hazards. Obey all safety messages that follow this symbol to avoid possible injury or death.



Indicates a imminently hazardous situation which, if not avoided, will result in death or serious injury.



Indicates a potentially hazardous situation which, if not avoided, could result in death or serious injury.



Indicates a potentially hazardous situation which, if not avoided, may cause minor or moderate injury.



Indicates a potentially hazardous situation which, if not avoided, may result in property damage.



Be sure to wear protective eye wear and other protective clothing if the situation warrants it.



Be aware of potential crushing hazards such as moving parts, free swinging or unsecured components when lifting or placing loads. Always wear approved steel-toed shoes.

## Workplace Safety

Any person working on or around a machine must be aware of all known safety hazards. Personal safety and the continued safe operation of the machine should be your top priority.



Be sure to keep sparks, flames and lighted tobacco away from flammable and combustible materials like battery gases and engine fuels. Always have an approved fire extinguisher within easy reach.



Be sure that all tools and working areas are properly maintained and ready for use. Keep work surfaces clean and free of debris that could get into machine components and cause damage.



Be sure any forklift, overhead crane or other lifting or supporting device is fully capable of supporting and stabilizing the weight to be lifted. Use only chains or straps that are in good condition and of ample capacity.



Be sure that fasteners intended for one time use (i.e., cotter pins and self-locking nuts) are not reused. These components may fail if they are used a second time.



Be sure to properly dispose of old oil or other fluids. Use an approved container. Please be environmentally safe.



Be sure that your workshop or work area is properly ventilated and well lit.

---

# Table of Contents

<b>Introduction</b>	<b>Introduction</b> ..... <b>ii</b>
	Important Information ..... ii
	Models included in this manual ..... iii
	Identifying the Correct Procedure for your Model ..... iii
	Find additional Manuals for your Model ..... iii
	Revision History .....iv
<hr/>	
<b>Section 1</b>	<b>Safety Rules</b> ..... <b>vi</b>
	General Safety Rules .....vi
<hr/>	
<b>Section 2</b>	<b>Specifications</b> ..... <b>1</b>
	Machine Specifications ..... 1
	Air Conditioner Refrigerant Specifications ..... 2
	<b>Performance Specifications</b> ..... <b>3</b>
	Performance Specifications ..... 3
	<b>Torque Specifications</b> ..... <b>5</b>
	Tires and Wheels ..... 5
	<b>Powertrain Specifications</b> ..... <b>6</b>
	Operator and Maintenance Manuals ..... 6
	Deutz Engine Models ..... 7
	John Deere Engine Models ..... 7
	Perkins Engine Models ..... 8
	Transmission Specifications ..... 9
	Axle Specifications ..... 10
	<b>Hydraulic Specifications</b> ..... <b>11</b>
	Hydraulic Relief Valves ..... 11
	Hydraulic Oil Specifications ..... 13
	Hydraulic Hose and Fitting Torque Specifications ..... 16
	Torque Procedure ..... 16



---

# Table of Contents

---

<b>Section 3</b>	<b>Maintenance Procedures.....</b>	<b>19</b>
	Introduction.....	19
	Maintenance Schedule.....	21
	Pre-Delivery Preparation Report.....	22
	Scheduled and Programmed Maintenance Inspection Report.....	23
	<b>Commissioning Procedures.....</b>	<b>24</b>
	C-1 Perform 50 Hour Service.....	24
	C-2 Perform Engine Maintenance – 50 Hours.....	24
	C-3 Perform 150 Hour Service.....	25
	<b>Quarterly Maintenance Procedures.....</b>	<b>26</b>
	Q-1 Check for Open Bulletins and Owner Registration.....	26
	Q-2 Battery inspection.....	27
	Q-3 Inspect the Electrical Wiring.....	28
	Q-4 Check the Boom Wear Pads.....	29
	Q-5 Check the Exhaust System.....	31
	Q-6 Inspect the Tires, Wheels and Lug Nut Torque.....	31
	Q-7 Inspect the Fork Level and Auxiliary Hydraulic Hoses Tension.....	32
	Q-8 Inspect the Fuel and Hydraulic Tank Cap Venting Systems.....	32
	Q-9 Visual Inspection of the Hydraulic Oil.....	34
	Q-10 Inspect the Engine Air Filter.....	35
	Q-11 Lubricate the Driveshaft.....	35
	Q-12 Inspect and Lubricate the Sequencing Chains.....	36

---

## Table of Contents

<b>Annual Maintenance Procedures .....</b>	<b>38</b>
A-1 Inspect the Forks .....	38
A-2 Adjust the Boom Sequencing Chains - GTH-636 and GTH-844.....	38
A-3 Adjust the Boom Sequencing Chains - GTH-1056.....	39
A-4 Adjust the Boom Sequencing Chains - GTH-1256 and GTH-1544.....	40
A-5 Replace Hydraulic Tank Return Filter Element .....	41
A-6 Replace the Cab Air Intake Filter Element (if equipped).....	41
<b>Programmed Maintenance Procedures .....</b>	<b>42</b>
P0-1 Lubricate the Boom .....	42
P0-2 Deutz Engine Maintenance – Under 1000 Hours.....	43
P0-3 Perkins Engine Maintenance – Under 1000 Hours .....	44
P0-4 John Deere Engine Maintenance – Under 1000 Hours .....	45
P0-5 Axle Maintenance – Under 1000 Hours .....	46
P0-6 Transmission Maintenance – Under 1000 Hours.....	48
P1-1 Perform Engine Maintenance – 1000 Hours .....	49
P1-2 Perform Transmission Maintenance – 1000 Hours.....	49
P1-3 Perform Axle Maintenance – 1000 Hours .....	50
P2-1 Perform Engine Maintenance – 2000 Hours .....	51
P2-2 Test or Replace the Hydraulic Oil .....	52
P3-1 Perform Engine Maintenance – 3000 Hours .....	53
P4-1 Perform Engine Maintenance – 4000 Hours .....	53
P6-1 Perform Engine Maintenance – 6000 Hours .....	54
P12-1 Perform Engine Maintenance – 12000 Hours.....	54

# Specifications

---

**GTH-636**

---

**Fluid capacities**

Fuel tank	27 gallons 102.2 liters
Hydraulic tank	34 gallons 128.7 liters
Hydraulic system (including tank)	46.5 gallons 176 liters

**GTH-844 (to SN GTH0816-21535)**

---

**Fluid capacities**

Fuel tank	35 gallons 132.5 liters
Hydraulic tank	40 gallons 151.4 liters
Hydraulic system (including tank)	55 gallons 208.2 liters

**GTH-844 (from SN GTH0816-21536,  
GTH0816E-10000)**

---

**Fluid capacities**

Fuel tank	32 gallons 121.1 liters
Hydraulic tank	35 gallons 132.5 liters
Hydraulic system (including tank)	50 gallons 189.3 liters
DEF tank	2.6 gallons 10 liters

---



---

**GTH-1056**

---

**Fluid capacities**

Fuel tank	35 gallons 132.5 liters
Hydraulic tank	44 gallons 166.5 liters
Hydraulic system (including tank)	55 gallons 208.2 liters

**GTH-1256, GTH-1544**

---

**Fluid capacities**

Fuel tank	47 gallons 178 liters
Hydraulic tank	48 gallons 182 liters
Hydraulic system (including tank)	77 gallons 291 liters

**GTH-5519**

---

**Fluid capacities**

Fuel tank	15.9 gallons 60 liters
Hydraulic tank	16.4 gallons 62 liters
Hydraulic system (including tank)	25 gallons 95 liters

---

---

# Specifications

## Air Conditioner Refrigerant Specifications

System Full Charge	R134a
GTH-636, GTH-844 and GTH-1056	1 lb 14 oz
GTH-1256, GTH-1544	2 lb 3 oz
GTH-5519	1 lb 10 oz

## Performance Specifications

### GTH-636

#### Drive speed, maximum

Deutz TD2.9 Engines	18 mph 29.0 km/h
---------------------	---------------------

Draw bar pull	15,100 lbs 6849 kg
---------------	-----------------------

Lift capacity, maximum	6000 lbs 2722 kg
------------------------	---------------------

#### Boom function speeds, maximum

Boom up	10 to 12 seconds
---------	------------------

Boom down	8 to 10 seconds
-----------	-----------------

Boom extend	11 to 13 seconds
-------------	------------------

Boom retract	9 to 11 seconds
--------------	-----------------

Fork rotate	3 to 6 seconds
-------------	----------------

Fork tilt up	6 to 8 seconds
--------------	----------------

Fork tilt down	5 to 7 seconds
----------------	----------------

### GTH-844

#### Drive speed, maximum

Deutz 3.6 TCD Engines	15 mph 24.1 km/h
-----------------------	---------------------

Perkins 1104D Engine	14 mph 22.5 km/h
----------------------	---------------------

Perkins 854 Engine	16 mph 25.7 km/h
--------------------	---------------------

Draw bar pull	21,000 lbs 9525 kg
---------------	-----------------------

Lift capacity, maximum	8000 lbs 3629 kg
------------------------	---------------------

#### Boom function speeds, maximum

Boom up	12 to 14 seconds
---------	------------------

Boom down	9 to 11 seconds
-----------	-----------------

Boom extend	13 to 15 seconds
-------------	------------------

Boom retract	8 to 10 seconds
--------------	-----------------

Fork rotate	3 to 6 seconds
-------------	----------------

Fork tilt up	6 to 8 seconds
--------------	----------------

Fork tilt down	5 to 7 seconds
----------------	----------------

### GTH-1056

#### Drive speed, maximum

All engines	19 mph 31.2 km/h
-------------	---------------------

Draw bar pull	22,900 lbs 10,387 kg
---------------	-------------------------

Lift capacity, maximum	10,000 lbs 4545 kg
------------------------	-----------------------

#### Boom function speeds, maximum

Boom up	12 to 14 seconds
---------	------------------

Boom down	9 to 11 seconds
-----------	-----------------

Boom extend	13 to 15 seconds
-------------	------------------

Boom retract	8 to 10 seconds
--------------	-----------------

Fork rotate	3 to 6 seconds
-------------	----------------

Fork tilt up	6.5 to 8.5 seconds
--------------	--------------------

Fork tilt down	6 to 8 seconds
----------------	----------------

### GTH-1256

#### Drive speed, maximum

All engines	18 mph 29 km/h
-------------	-------------------

Draw bar pull	22,500 lbs 10,206 kg
---------------	-------------------------

Lift capacity, maximum	12,000 lbs 5450 kg
------------------------	-----------------------

#### Boom function speeds, maximum

Boom up	16 seconds
---------	------------

Boom down	13 seconds
-----------	------------

Boom extend	22 seconds
-------------	------------

Boom retract	15 seconds
--------------	------------

Fork tilt up	5 seconds
--------------	-----------

Fork tilt down	4 seconds
----------------	-----------

## Performance Specifications

<b>GTH-1544</b>		<b>GTH-5519</b>	
<b>Drive speed, maximum</b>		<b>Drive speed, maximum</b>	
All engines	18 mph 29 km/h	All engines	16 mph 25.8 km/h
Draw bar pull	22,500 lbs 10,206 kg	Draw bar pull	9200 lbs 4173 kg
Lift capacity, maximum	15,000 lbs 6804 kg	Lift capacity, maximum	5,500 lbs 2,500 kg
<b>Boom function speeds, maximum</b>		<b>Boom function speeds, maximum</b>	
Boom up	19 seconds	Boom up	7 seconds
Boom down	15 seconds	Boom down	7 seconds
Boom extend	17 seconds	Boom extend	7 seconds
Boom retract	14 seconds	Boom retract	4 seconds
Fork tilt up	7 seconds	Fork tilt up	4 seconds
Fork tilt down	7 seconds	Fork tilt down	3 seconds

## Torque Specifications

---

### GTH-636

Lug nut torque	465 ft-lb 630 Nm
Tire pressure (models with air-filled tires)	58 psi 4.3 bar

---

### GTH-844

Lug nut torque	295 ft-lb 400 Nm
Tire pressure (models with air-filled tires)	62 psi 4.3 bar

---

### GTH-1056

Lug nut torque	465 ft-lb 630 Nm
Tire pressure (models with air-filled tires)	62 psi 4.27 bar

---

### GTH-1256

Lug nut torque	465 ft-lb 630 Nm
Tire pressure (models with air-filled tires)	87 psi 6 bar

---

### GTH-1544

Lug nut torque	465 ft-lb 630 Nm
Tire pressure (models with air-filled tires)	87 psi 6 bar

---

### GTH-5519

Lug nut torque	295 ft-lb 400 Nm
Tire pressure (models with air-filled tires)	65 psi 4.5 bar

## Powertrain Specifications

### Engine Operator and Maintenance Manuals

<b>Deutz TD 2.9 L4</b>	
Genie part number	1251561
<b>Deutz TCD3.6 L4</b>	
Genie part number	218707
<b>Deutz TCD 4.1 L4</b>	
Genie part number	57.4700.0004
<b>Perkins 854F-E34T</b>	
Genie part number	218708
<b>Perkins 1104D-E44TA</b>	
Genie part number	117765
<b>Perkins 1204E-E44TA</b>	
Genie part number	218726
<b>John Deere 4045TH485</b>	
Genie part number	123703

### Transmission Operator and Maintenance Manuals

<b>Carraro 26.27M</b>	
Genie part number	218710
<b>Dana Integral Gear Box Shift on Fly</b>	
Genie part number	57.4700.0007
<b>Dana T20000</b>	
Genie part number	115025
<b>Dana VDT12000</b>	
Genie part number	218706
<b>ZF 4 WG-98 TC</b>	
Genie part number	1258405

### Axle Operator and Maintenance Manuals

<b>Comer</b>	
Genie part number	57.4700.0020
<b>Dana 212</b>	
Genie part number	1259569
<b>Dana Planetary 213</b>	
Genie part number	115026



## Powertrain Specifications

### Deutz Engine Models

#### TD 2.9 L4, GTH-636

Standby idle	1000 rpm
Low idle	950 rpm
High idle	2600 rpm
Oil capacity (including filter)	9.4 quarts
Units ship with 15W-40.	9 liters
Engine coolant capacity	12.4 quarts
Type: Extended Life 50/50	11.7 liters

#### TD 2.9 L4, GTH-5519

Low idle	1000 rpm
High idle	2700 rpm
Oil capacity (including filter)	8.5 quarts
	8 liters

Units ship with 15W-40 Shell Rimula R4 L.

Engine coolant capacity	3.3 gallons
Type: Extended Life	12,5 liters

#### TCD 3.6 L4, GTH-844, GTH-1056

Low idle	1000 rpm
High idle	2400 rpm
Oil capacity (including filter)	9.5 quarts
	9 liters

Units ship with 15W-40 API CJ4 low ash oil.

Engine coolant capacity	4.5 gallons
Type: Extended Life	17 liters

#### TCD 4.1 L4, GTH-1256, GTH-1544

Low idle	920 rpm
High idle	2300 rpm
Oil capacity (including filter)	12.1 quarts
	11.5 liters

Units ship with 15W-40 API CJ4 low ash oil.

Engine coolant capacity	7.6 gallons
Type: Ethylene Glycol	29 liters

Extreme operating temperatures may require the use of alternative engine oils. For oil requirements, refer to the Engine Operator Manual for your engine.

### John Deere Engine Models

#### 4045HF485, GTH-1056

Low idle	8000 rpm
High idle	2400 rpm
Oil capacity (including filter)	14 quarts
	13.2 liters

Oil type	15W-40
----------	--------

Units ship with John Deere Engine Break-In Oil. During the break-in period, add John Deere Engine Break-In Oil as needed to maintain the specified oil level.

Engine coolant capacity	7 gallons
Type: Extended Life	26.5 liters

Extreme operating temperatures may require the use of alternative engine oils. For oil requirements, refer to the Engine Operator Manual for your engine.

## Powertrain Specifications

### Perkins Engine Models

#### 854E-E34TA, GTH-844

Low idle	1000 rpm
High idle	2700 rpm
Oil capacity (including filter)	8.8 quarts 8.3 liters

Units ship with 15W-40 API CJ4 low ash oil.

Engine coolant capacity	4.9 gallons 18.5 liters
-------------------------	----------------------------

#### 1104D-E44TA, GTH-844, GTH-1056

Low idle	1000 rpm
High idle	2500 rpm
Oil capacity (including filter)	10 quarts 9.6 liters

Units ship with 15W-40.

Engine coolant capacity	4.6 gallons
Type: Extended Life	17.4 liters

#### 1204E-E44TA, GTH-1056

Low idle	800 rpm
High idle	2200 rpm
Oil capacity (including filter)	8.8 quarts 8.3 liters

Units ship with 15W-40 API CJ4 low ash oil.

Engine coolant capacity	4.9 gallons
Type: Extended Life	18.5 liters

#### 1204E-E44TA, GTH-1256, GTH-1544

Low idle	800 rpm
High idle	2200 rpm
Oil capacity (including filter)	14.8 quarts 14 liters

Units ship with 15W-40 API CJ4 low ash oil.

Engine coolant capacity	7.7 gallons
Type: Ethylene Glycol	29 liters

Extreme operating temperatures may require the use of alternative engine oils. For oil requirements, refer to the Engine Operator Manual for your engine.

## Powertrain Specifications

### Dana Transmission Models

#### Dana Integral Gear Box Shift on Fly

Transmission Type: Hydrostatic with Mechanical Gear, 2 speed

Oil capacity, gear box 1.69 quarts  
1.6 liters

Units ship with SAE 85W90 API GL4.

#### Dana T20000

Transmission Type: 3 speed powershift

Oil capacity, gear box 20 quarts  
18.9 liters

Units ship with Chevron RPM SAE 10W.

Extreme operating temperatures may require the use of alternative transmission oils. For oil requirements, refer to the Dana T20000 Maintenance Manual.

#### Dana VDT12000

Transmission Type: 3 speed powershift

Oil capacity, transmission 14.3 quarts  
13.5 liters

Oil capacity, gear box 1.1 quarts  
1 liters

Units ship with Chevron Ursa Hydraulic 10W.

Extreme operating temperatures may require the use of alternative transmission oils. For oil requirements, refer to the Dana VDT12000 Service Manual.

### ZF Transmission Models

#### ZF 4 WG-98 TC

Transmission Type: 4 speed powershift

Oil capacity 16.9 quarts  
16 liters

Units ship with Chevron Delo 400 LE SAE 15W40.

Extreme operating temperatures may require the use of alternative transmission oils. For oil requirements, refer to the ZF 4 WG-98 TC Maintenance Manual.

## Powertrain Specifications

### Carraro Axle Models

#### Carraro 26.27M Drive Axle

##### Front Axle Lubrication

Front differential	7.4 quarts 7 liters
Axle planetary end (each)	0.8 quarts 0.8 liters

##### Rear Axle Lubrication

Rear differential	7.9 quarts 7.5 liters
Axle planetary end (each)	0.8 quarts 0.8 liters

##### Oil viscosity requirements

Differential	Chevron Supreme 80W90 L
Planetary ends	Chevron Supreme 80W90 L

### Comer Axle Models

#### Comer Drive Axle

##### Front Axle Lubrication

Front differential	5.28 quarts 5 liters
Axle planetary end (each)	1 quart 0.95 liters

##### Rear Axle Lubrication

Rear differential	5.28 quarts 5 liters
Axle planetary end (each)	1 quart 0.95 liters

##### Drop Box Lubrication

Drop Box	1.04 quarts 0.98 liters
----------	----------------------------

##### Oil viscosity requirements

Differential	API GL5 (MIL L-2105)
Planetary ends	API GL5 (MIL L-2105)

### Dana Axle Models

#### Dana 212 Drive Axle

##### Front Axle Lubrication

Front differential	7.4 quarts 7 liters
Axle planetary end (each)	0.8 quarts 0.8 liters

##### Rear Axle Lubrication

Rear differential	8 quarts 7.6 liters
Axle planetary end (each)	0.8 quarts 0.8 liters

##### Oil viscosity requirements

Differential	Chevron Supreme 85W90 (API GL5)
Planetary ends	Chevron Supreme 85W90 (API GL5)

#### Dana Planetary 213 Drive Axle

##### Front Axle Lubrication

Front differential	15 quarts 14.2 liters
Axle planetary end (each)	2 quarts 1.9 liters

##### Rear Axle Lubrication

Rear differential	15 quarts 14.2 liters
Axle planetary end (each)	2 quarts 1.9 liters

##### Oil viscosity requirements

Differential	Chervron Supreme 80W90 LS
Planetary ends	Chervron Supreme 80W90 LS

## Hydraulic Specifications

### GTH-636

#### Primary Function Manifold

System pressure, maximum	3200 psi 221 bar
Fork tilt relief valve pressure, maximum	3500 psi 241 bar
Flow regulator, Sway circuit	2 gpm 7.5 L/min

#### Secondary Function Manifold

Steer relief valve pressure, maximum	2650 psi 182.7 bar
Parking brake relief valve pressure, maximum	350 psi 24.1 bar
Joystick relief valve pressure, maximum	400 psi 27.5 bar

### GTH-844

#### Primary Function Manifold

System pressure, maximum	3250 psi 224 bar
Fork tilt relief valve pressure, maximum	3500 psi 241 bar
Flow regulator, Sway circuit	2 gpm 7.5 L/min

#### Secondary Function Manifold

Steer relief valve pressure, maximum	2650 psi 182.7 bar
Parking brake relief valve pressure, maximum	350 psi 24.1 bar
Differential lock relief valve pressure, maximum	400 psi 27.5 bar
Rear lock-up relief valve pressure, maximum	50 psi 3.4 bar

### GTH-1056

#### Primary Function Manifold

System pressure, maximum	3200 psi 221 bar
Boom extend relief valve pressure, maximum	3500 psi 241 bar
Fork tilt relief valve pressure, maximum	3500 psi 241 bar
Flow regulator, Fork tilt circuit	14 gpm 53 L/min
Flow regulator, Sway circuit	2 gpm 7.5 L/min
Flow regulator, Pilot pressure bleed circuit	0.1 gpm 1.4 L/min

#### Secondary Function Manifold

Steer relief valve pressure, maximum	2500 psi 172 bar
Parking brake relief valve pressure, maximum	400 psi 27.5 bar
Differential lock relief valve pressure, maximum	400 psi 27.5 bar
Rear lock-up relief valve pressure, maximum	50 psi 3.4 bar

#### Outrigger Manifold

Flow regulator, Outrigger circuit	6 gpm 22.7 L/min
-----------------------------------	---------------------

## Hydraulic Specifications

### GTH-1256

#### Function Manifold

System relief valve pressure, maximum	4060 psi 280 bar
Fork tilt relief valve pressure, maximum	4350 psi 300 bar

#### Auxiliary function manifold - Outriggers /chassis leveling

Steer relief valve pressure, maximum	2610 psi 180 bar
Parking brake relief valve pressure, maximum	406 psi 28 bar
Differential lock relief valve pressure, maximum	406 psi 28 bar
Rear lock-up relief valve pressure, maximum	406 psi 28 bar
Sway relief valve pressure, maximum	3335 psi 230 bar
Auxiliary line relief valve pressure, maximum	3335 psi 230 bar
Transmission gearbox speed shifting relief valve pressure, maximum	406 psi 28 bar

### GTH-1544

#### Function Manifold

System relief valve pressure, maximum	3770 psi 260 bar
Fork tilt relief valve pressure, maximum	4060 psi 280 bar

#### Secondary Function Valves

Steer relief valve pressure, maximum	2610 psi 180 bar
Parking brake relief valve pressure, maximum	406 psi 28 bar
Differential lock relief valve pressure, maximum	406 psi 28 bar
Rear lock-up relief valve pressure, maximum	406 psi 28 bar
Sway relief valve pressure, maximum	3335 psi 230 bar
Auxiliary line relief valve pressure, maximum	3335 psi 230 bar
Transmission gearbox speed shifting relief valve pressure, maximum	406 psi 28 bar

### GTH-5519

#### Function Manifold

System relief valve pressure, maximum	3915 psi 270 bar
Fork tilt relief valve pressure, maximum	4205 psi 290 bar

#### Secondary Function Valves

Steer relief valve pressure, maximum	2030 psi 140 bar
Steer anti-shock relief valve pressure, maximum	2900 psi 200 bar
Parking brake relief valve pressure, maximum	360 psi 25 bar
Auxiliary line relief valve pressure, maximum	3915 psi 270 bar

# Hydraulic Specifications

## Hydraulic Oil Specifications

### Hydraulic Fluid Specifications

Genie specifications require hydraulic oils which are designed to give maximum protection to hydraulic systems, have the ability to perform over a wide temperature range, and the viscosity index should exceed 140. They should provide excellent antiwear, oxidation prevention, corrosion inhibition, seal conditioning, and foam and aeration suppression properties.

Cleanliness level, minimum	ISO 15/13
-------------------------------	-----------

Water content, maximum	250 ppm
---------------------------	---------

### Recommended Hydraulic Fluid

Hydraulic oil type	Chevron Rando HD Premium
--------------------	--------------------------

Viscosity grade	32
-----------------	----

Viscosity index	200
-----------------	-----

### Optional Hydraulic Fluids

Mineral based	Shell Tellus S2 V 32
	Shell Tellus S2 V 46
	Shell Tellus S4 VX 32 Shell
	Shell Donax TG (Dexron III) Chevron 5606A

Biodegradable	Petro Canada Environ MV 46
---------------	----------------------------

Fire resistant	UCON Hydrolube HP-5046
----------------	------------------------

Note: Genie specifications require additional equipment and special installation instructions for the approved optional fluids. Consult Genie Product Support before use.

**NOTICE** Optional fluids may not have the same hydraulic lifespan and may result in component damage.

Note: Extended machine operation can cause the hydraulic fluid temperature to increase beyond its maximum allowable range. If the hydraulic fluid temperature consistently exceeds 200°F / 90°C an optional oil cooler may be required.

### NOTICE

Do not top off with incompatible hydraulic fluids. Hydraulic fluids may be incompatible due to the differences in base additive chemistry. When incompatible fluids are mixed, insoluble materials may form and deposit in the hydraulic system, plugging hydraulic lines, filters, control valves and may result in component damage.

Note: Do not operate the machine when the ambient air temperature is consistently above 120°F / 49°C.

## Hydraulic Fluid Temperature Range

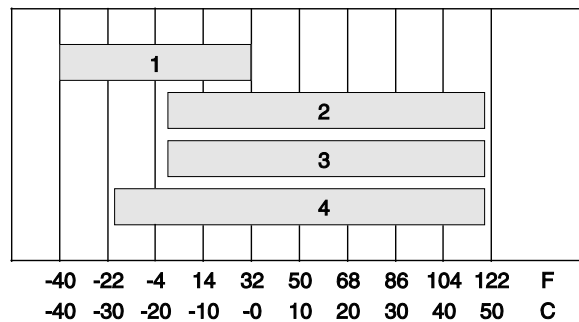

Ambient air temperature

- 1 Chevron hydraulic oil 5606A
- 2 Petro-Canada Environ MV 46
- 3 UCON Hydrolube HP-5046D
- 4 Chevron Rando HD premium oil MV

## Hydraulic Specifications

### Chevron Rando HD Premium Oil MV Fluid Properties

ISO Grade	32
Viscosity index	200
Kinematic Viscosity cSt @ 200°F / 100°C	7.5
cSt @ 104°F / 40°C	33.5
Brookfield Viscosity cP @ -4°F / -20°C	1040
cP @ -22°F / -30°C	3310
Flash point	375°F / 190°C
Pour point	-58°F / -50°C
Maximum continuous operating temperature	171°F / 77°C

Note: A hydraulic oil heating system is recommended when the ambient temperature is consistently below 0°F / -18°C.

Note: Do not operate the machine when the ambient temperature is below -20°F / -29°C with Rando HD Premium MV.

### Chevron 5606A Hydraulic Oil Fluid Properties

ISO Grade	15
Viscosity index	300
Kinematic Viscosity cSt @ 200°F / 100°C	5.5
cSt @ 104°F / 40°C	15.0
cSt @ -40°F / -40°C	510
Flash point	180°F / 82°C
Pour point	-81°F / -63°C
Maximum continuous operating temperature	124°F / 51°C

Note: Use of Chevron 5606A hydraulic fluid, or equivalent, is required when ambient temperatures are consistently below 0°F / -17°C unless an oil heating system is used.

#### **NOTICE**

Continued use of Chevron 5606A hydraulic fluid, or equivalent, when ambient temperatures are consistently above 32°F / 0°C may result in component damage



## Hydraulic Specifications

### Petro-Canada Environ MV 46 Fluid Properties

ISO Grade	46
Viscosity index	154
Kinematic Viscosity	
cSt @ 200°F / 100°C	8.0
cSt @ 104°F / 40°C	44.4
Flash point	482°F / 250°C
Pour point	-49°F / -45°C
Maximum continuous operating temperature	180°F / 82°C

### Shell Tellus S4 VX Fluid Properties

ISO Grade	32
Viscosity index	300
Kinematic Viscosity	
cSt @ 200°F / 100°C	9
cSt @ 104°F / 40°C	33.8
Brookfield Viscosity	
cSt @ -4°F / -20°C	481
cSt @ -13°F / -25°C	702.4
cSt @ -40°F / -40°C	2624
Flash point	>100
Pour point	-76°F / -60°C
Maximum continuous operating temperature	103°F / 75°C

### UCON Hydrolube HP-5046 Fluid Properties

ISO Grade	46
Viscosity index	192
Kinematic Viscosity	
cSt @ 149°F / 65°C	22
cSt @ 104°F / 40°C	46
cSt @ 0°F / -18°C	1300
Flash point	None
Pour point	-81°F / -63°C
Maximum continuous operating temperature	189°F / 87°C

## Hydraulic Specifications

### Hydraulic Hose and Fitting Torque Specifications

Your machine is equipped with Parker Seal-Lok™ ORFS or 37° JIC fittings and hose ends. Genie specifications require that fittings and hose ends be torqued to specification when they are removed and installed or when new hoses or fittings are installed.

Seal-Lok™ Fittings (hose end - ORFS)	
SAE Dash Size	Torque
-4	10 ft-lbs / 13.6 Nm
-6	30 ft-lbs / 40.7 Nm
-8	40 ft-lbs / 54.2 Nm
-10	60 ft-lbs / 81.3 Nm
-12	85 ft-lbs / 115 Nm
-16	110 ft-lbs / 150 Nm
-20	140 ft-lbs / 190 Nm
-24	180 ft-lbs / 245 Nm

JIC 37° Fittings (swivel nut or hose connection)		
SAE Dash Size	Thread Size	Flats
-4	7/16-20	2
-6	9/16-18	1 ¼
-8	3/4-16	1
-10	7/8-14	1
-12	1 1/16-12	1
-16	1 5/16-12	1
-20	1 5/8-12	1
-24	1 7/8-12	1

### SAE O-ring Boss Port

(tube fitting - installed into Aluminum)  
(all types)

SAE Dash Size	Torque
-4	14 ft-lbs / 19 Nm
-6	23 ft-lbs / 31.2 Nm
-8	36 ft-lbs / 54.2 Nm
-10	62 ft-lbs / 84 Nm
-12	84 ft-lbs / 114 Nm
-16	125 ft-lbs / 169.5 Nm
-20	151 ft-lbs / 204.7 Nm
-24	184 ft-lbs / 249.5 Nm

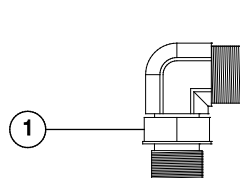

Adjustable Fitting



Non-adjustable fitting

1 jam nut

### SAE O-ring Boss Port

(tube fitting - installed into Steel)

SAE Dash Size	Torque
-4 ORFS / 37° (Adj)	15 ft-lbs / 20.3 Nm
ORFS (Non-adj)	26 ft-lbs / 35.3 Nm
37° (Non-adj)	22 ft-lbs / 30 Nm
-6 ORFS (Adj / Non-adj)	35 ft-lbs / 47.5 Nm
37° (Adj / Non-adj)	29 ft-lbs / 39.3 Nm
-8 ORFS (Adj / Non-adj)	60 ft-lbs / 81.3 Nm
37° (Adj / Non-adj)	52 ft-lbs / 70.5 Nm
-10 ORFS (Adj / Non-adj)	100 ft-lbs / 135.6 Nm
37° (Adj / Non-adj)	85 ft-lbs / 115.3 Nm
-12 (All types)	135 ft-lbs / 183 Nm
-16 (All types)	200 ft-lbs / 271.2 Nm
-20 (All types)	250 ft-lbs / 339 Nm
-24 (All types)	305 ft-lbs / 413.5 Nm

## Hydraulic Specifications

### Torque Procedure

#### Seal-Lok™ fittings

- 1 Replace the O-ring. The O-ring must be replaced anytime the seal has been broken. The O-ring cannot be re-used if the fitting or hose end has been tightened beyond finger tight.

Note: The O-ring in Parker Seal Lok™ fittings and hose end are custom-size O-rings. They are not standard size O-rings. They are available in the O-ring field service kit (Genie part number 49612).

- 2 Lubricate the O-ring before installation.
- 3 Be sure the O-ring face seal is seated and retained properly.
- 4 Position the tube and nut squarely on the face seal end of the fitting, and tighten the nut finger tight.
- 5 Tighten the nut or fitting to the appropriate torque. Refer to the appropriate torque chart in this section.
- 6 Operate all machine functions and inspect the hose, fittings and related components to confirm there are no leaks.

#### JIC 37° fittings

- 1 Align the tube flare (hex nut) against the nose of the fitting body (body hex fitting) and tighten the hex nut to the body hex fitting to hand tight, approximately 30 in-lbs / 3.4 Nm.
- 2 Using a permanent ink marker, make a reference mark on one the flats of the hex nut and continue the mark onto the body of the hex fitting. Refer to Illustration 1.

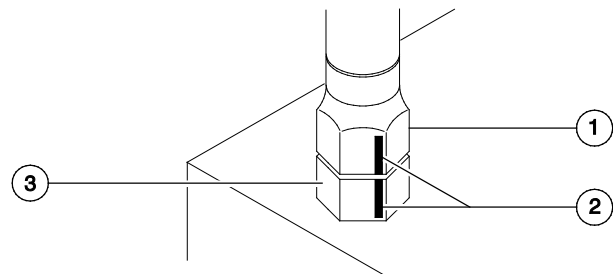

Illustration 1

- 1 hex nut
- 2 reference mark
- 3 body hex fitting

## Hydraulic Specifications

- 3 Working clockwise on the body hex fitting, make a second mark with a permanent ink marker to indicate the proper tightening position. Refer to Illustration 2.

Note: Use the JIC 37° Fitting table in this section to determine the correct number of flats, for the proper tightening position.

Note: The marks indicate the correct tightening positions have been determined. Use the second mark on the body hex fitting to properly tighten the joint after it has been loosened.

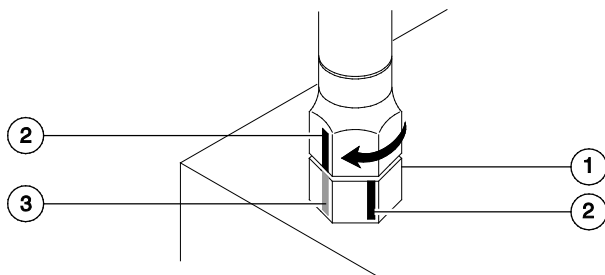

Illustration 2

- 1 body hex fitting
- 2 reference mark
- 3 second mark

- 4 Tighten the hex nut until the mark on the hex nut is aligned with the second mark on the body hex fitting.
- 5 Operate all machine functions and inspect the hose, fittings and related components to confirm there are no leaks.

## Maintenance Procedures



### Observe and Obey:

- ☑ Maintenance inspections shall be completed by a person trained and qualified on the maintenance of this machine.
- ☑ Scheduled maintenance inspections shall be completed as specified on the *Maintenance Inspection Reports*. The frequency and extent of periodic examinations and tests may also depend on national regulations.

### **▲ WARNING**

Failure to perform each procedure as presented and scheduled may cause death, serious injury or substantial damage.

- ☑ Immediately tag and remove from service a damaged or malfunctioning machine.
- ☑ Repair any machine damage or malfunction before operating the machine.
- ☑ Use only Genie approved replacement parts.
- ☑ Machines that have been out of service for a period longer than 3 months must complete the quarterly inspection.

### Machine Configuration:

- ☑ Unless otherwise specified, perform each procedure with the machine in the following configuration:
  - Machine parked on a firm, level surface
  - Boom in the stowed position
  - Key switch in the off position with the key removed
  - Wheels chocked

# Maintenance Procedures

## About This Section

This section contains detailed procedures for each scheduled maintenance inspection.

Each procedure includes a description, safety warnings and step-by-step instructions.

### Symbols Legend



Safety alert symbol—used to alert personnel to potential personal injury hazards. Obey all safety messages that follow this symbol to avoid possible injury or death.



Indicates a imminently hazardous situation which, if not avoided, will result in death or serious injury.



Indicates a potentially hazardous situation which, if not avoided, could result in death or serious injury.



Indicates a potentially hazardous situation which, if not avoided, may cause minor or moderate injury.



Indicates a potentially hazardous situation which, if not avoided, may result in property damage.

- ⊙ Indicates that a specific result is expected after performing a series of steps.
- ⊗ Indicates that an incorrect result has occurred after performing a series of steps.

## Maintenance Symbols Legend

Note: The following symbols have been used in this manual to help communicate the intent of the instructions. When one or more of the symbols appear at the beginning of a maintenance procedure, it conveys the meaning below.



Indicates that tools will be required to perform this procedure.



Indicates that new parts will be required to perform this procedure.



Indicates that dealer service will be required to perform this procedure.



Indicates that a cold motor/pump or engine will be required to perform this procedure.



Indicates that a warm engine will be required to perform this procedure.

# Maintenance Procedures

## Maintenance Schedule

The maintenance procedures have been divided into subsections that include: Commissioning, Quarterly, Annually and Programmed maintenance intervals. The maintenance inspection report has been divided into general areas of the machine that include: Drive Chassis, Booms and Fork, Functions and Controls and Powertrain.

Failure to perform these procedures may result in poor performance, component damage and unsafe operating conditions. They are essential to safe operation, machine performance and service life.

**Commissioning:** A series of required one time maintenance procedures to be performed at 50 and 150 hour intervals.

**Quarterly and Annually:** A series of maintenance procedures to be performed quarterly or annually.

**Programmed:** A series of maintenance procedures to be performed during a Pre-Delivery Preparation or based on machine operating hours.







## Maintenance Inspection Report

The maintenance inspection report contains checklists for each type of scheduled inspection.







Make copies of the *Maintenance Inspection Report* to use for each inspection. Maintain completed forms for a minimum of 4 years or in compliance with your employer, jobsite and governmental regulations and requirements.

### Instruction Examples









#### Commissioning Example:

<b>Commissioning</b>		 50	 150
 Engine - all models	 PO-1		





#### Quarterly and Annually Example:

 <b>Drive Chassis</b>	 <b>Intervals</b>	Q	A
 Inspect the tires, wheels and Lug Nut Torque	 Q-4		 $\emptyset$

#### Programmed Example (under 1000 HRS):

<b>Programmed Maintenance - Under 1000 HRS</b>		Status	Enter Hours
 Check Track Tension/Fastener Torque	 PO-1		 50
 Engines - Deutz Under 1000 HRS	 PO-2		

#### Programmed Example:

<b>Programmed Maintenance</b>	 Hours are in thousands					
<b>All models</b>	1	2	3	4	6	12
 Engine - all models, 1000 hrs	 P1-1		$\emptyset$	$\emptyset$	$\emptyset$	$\emptyset$

#### Instructions Legend

Use the following detailed descriptions to identify the intended use of the maintenance inspection reports.

-  Specific Interval: blank box is the interval to be completed and the  $\emptyset$  marks the interval as not required.

---

-  The description of the procedure or checklist to be completed.

---

-  The procedure number or checklist to be completed.

---

-  Check box to indicate status of inspection.

---

-  Specific interval is not required for this procedure.

---

-  General area of the machine to complete the procedure.

---

-  If this box has a designated time interval: this is the specific time interval to complete the procedure or checklist.

If this box is empty: the maintenance checklist will include multiple time intervals, use this box to write in the specific interval for the inspection completed.

# Pre-Delivery Preparation Report

## Fundamentals

It is the responsibility of the owner or dealer to perform the Pre-delivery Preparation.

The Pre-delivery Preparation is performed prior to each delivery. The inspection is designed to discover if anything is apparently wrong with a machine before it is put into service.

A damaged or modified machine must never be used. If damage or any variation from factory delivered condition is discovered, the machine must be tagged and removed from service.

Repairs to the machine may only be made by a qualified service technician, according to the manufacturer's specifications.

Scheduled maintenance inspections shall be performed by qualified service technicians, according to the manufacturer's specifications and the requirements listed in the responsibilities manual.

## Instructions

Use the operator's manual on your machine.

The Pre-delivery Preparation consists of completing the Pre-operation Inspection, the Maintenance items and the Function Tests.

Use this form to record the results. Place a check in the appropriate box after each part is completed. Follow the instructions in the operator's manual.

If any inspection receives an N, remove the machine from service, repair and re-inspect it. After repair, place a check in the R box.

### Legend

Y = yes, acceptable

N = no, remove from service

R = repaired

### Comments

Pre-delivery Preparation	Y	N	R
Pre-operation inspection completed			
Maintenance items completed			
Function tests completed			



A TEREX BRAND

**Terex South Dakota, Inc USA**  
 500 Oak Wood Road  
 PO Box 1150  
 Watertown, SD 57201-6150  
 (605) 882-4000

**Genie UK**  
 The Maltings, Wharf Road  
 Grantham, Lincolnshire  
 NG31- 6BH England  
 (44) 1476-584333

\_\_\_\_\_

**Model**

\_\_\_\_\_

**Serial number**

\_\_\_\_\_

**Date**

\_\_\_\_\_

**Machine owner**

\_\_\_\_\_

**Inspected by (print)**

\_\_\_\_\_

**Inspector signature**

\_\_\_\_\_

**Inspector title**

\_\_\_\_\_

**Inspector company**



Model		Hour meter	Date
Serial number		Inspector company	Machine owner
Inspected by (print)		Inspector signature	
<b>Scheduled Maintenance:</b> Inspection Type Q = quarterly or frequent inspections A = annual inspections	<b>Legend</b> Y = yes, acceptable N = no, remove from service R = repaired ∅ = not applicable	Make copies of this report to use for each inspection. Select the appropriate procedures for the type of inspection(s) to perform.	<b>Programmed Maintenance:</b> Programmed maintenance will be completed based on machine hours. This program includes the onetime or commissioning procedures for new products. The onetime procedures will be completed at 50 or 150 hours.
If any inspection receives an "N," tag and remove the machine from service, repair and re-inspect it. After repair, place a "R" in the box.			

Drive Chassis	Intervals	Q	A
Inspect the Tires, Wheels and Lug Nut Torque	Q-6		
Mechanicals and Hydraulics	Intervals	Q	A
Inspect the Fuel and Hydraulic Tank Cap Venting Systems	Q-8		
Visual Inspection of the Hydraulic Oil	Q-9		
Replace Hydraulic Tank Return Filter Element	A-5	∅	
Replace the Cab Air Intake Filter (if equipped)	A-6	∅	
Electrical	Intervals	Q	A
Battery Inspection	Q-2		
Inspect the Electrical Wiring	Q-3		
Powertrain	Intervals	Q	A
Check the Exhaust System	Q-5		
Inspect the Engine Air Filter	Q-10		
Lubricate the Driveshaft	Q-11		
Boom(s) and Fork	Intervals	Q	A
Check the Boom Wear Pads	Q-4		
Inspect the Fork Level and Aux. Hydraulic Hoses	Q-7		
Inspect and Lubricate the Sequencing Chains - GTH-636, 1256, 1544, 844, 1056	Q-12		
Inspect the Forks	A-1	∅	
Adjust the Boom Chains - GTH-636, GTH-844	A-2	∅	
Adjust the Boom Chains - GTH-1056	A-3	∅	
Adjust the Boom Chains - GTH-1256, GTH-1544	A-4	∅	
Functions and Controls	Intervals	Q	A
Check for Open Bulletins and Owner Registration	Q-1		

Commissioning	50	150
Perform 50 Hour Service	C-1	∅
Engine Maintenance - 50 HRS	C-2	∅
150 Hour Service	C-3	∅

Programmed Maintenance - Under 1000 HRS	Status	Enter Hours
Lubricate the Boom	P0-1	8
Deutz Engine Maintenance – Under 1000 HRS	P0-2	
Perkins Engine Maintenance – Under 1000 HRS	P0-3	
John Deere Engine Maintenance – Under 1000 HRS	P0-4	
Axle Maintenance – Under 1000 HRS	P0-5	
Transmission Maintenance – Under 1000 HRS	P0-6	

Programmed Maintenance	Hours are in thousands						
All models	Perform every:	1	2	3	4	6	12
Engines - all models, 1000 HRS	P1-1		∅	∅	∅	∅	∅
Transmissions - all models, 1000 HRS	P1-2		∅	∅	∅	∅	∅
Axles - all models, 1000 HRS	P1-3		∅	∅	∅	∅	∅
Engines - all models, 2000 HRS	P2-1	∅		∅	∅	∅	∅
Test or Replace the Hydraulic Oil	P2-2	∅		∅	∅	∅	∅
Engines - all models, 3000 HRS	P3-1	∅	∅		∅	∅	∅
Engines - all models, 4000 HRS	P4-1	∅	∅	∅		∅	∅
Engines - all models, 6000 HRS	P6-1	∅	∅	∅	∅		∅
Engines - all models, 12000 HRS	P12-1	∅	∅	∅	∅	∅	

## Commissioning Procedures

### C-1 Perform 50 Hour Service



The 50 hour maintenance procedure is a one time sequence of procedures to be performed after the first 50 hours of usage. After this interval, refer to the maintenance inspection report for continued scheduled maintenance.

- 1 Perform the following maintenance procedures:

#### All Models:

- Q-6 Inspect the Tires, Wheels and Lug Nut Torque
- A-5 Replace the Hydraulic Filters

### C-2 Perform Engine Maintenance - 50 Hours



The 50 hour maintenance procedure is a one time sequence of procedures to be performed after the first 50 hours of usage. After this interval, refer to the maintenance inspection report for continued scheduled maintenance.

#### All Models

- Check Belt Tension
- Check The Engine Mounts
- Check Hose Clamps

#### John Deere Models

- Engine oil - replace
- Engine filter - replace

Required maintenance procedures and additional engine information are available in the manufacturer's manuals. Refer to Specifications, *Engine Operator and Maintenance Manuals*.

---

## Commissioning Procedures

### C-3

### Perform 150 Hour Service



The 150 hour maintenance procedure is a one time sequence of procedures to be performed after the first 150 hours of usage. After this interval, refer to the maintenance tables for continued scheduled maintenance.

- 1 Perform the following maintenance procedures:

Q-9 Visual Inspection of the Hydraulic Oil

## Quarterly Maintenance Procedures

### Q-1 Check for Open Bulletins and Owner Registration



Genie specifications require that this procedure be performed quarterly.

Completing required bulletins is essential to safe machine operation. An important way to ensure your machine has no open bulletins is to frequently check the serial number of your Genie machine against our bulletin database. Using the links below you can view any open bulletins for your machine(s) that require mandatory and immediate work to be completed.

Note: If you are unable to access this information on our websites, please contact your local Genie representative using the contact information provided on the back cover of this manual.

- 1 Locate the serial number plate or label on your machine and document your Genie machine serial number (exactly as its displayed on the serial plate or label).
- 2 Confirm that Genie has the current machine owner information on file by contacting our warranty department at 1-800-536-1800 or use the link included in this procedure to download and complete a New Owner Registration Form.
- 3 Using the link provided, check for current bulletins for your machine(s).

#### Machines purchased in Australia:

Go to [Australia Bulletins](http://genielift.com.au/contact)  
(<http://genielift.com.au/contact>)

- 1 Contact any one of the Genie Service centers around Australia to arrange for factory trained technicians to attend to your equipment needs.

#### Machines purchased in ASIA, North America and Latin America:

Go to [ASIA, North America and Latin America](https://www.gogenielift.com/)  
(<https://www.gogenielift.com/>)



CUSTOMER LOGIN  
SERVICE & PARTS MANUALS  
CONTACT INFORMATION  
REQUEST NEW ACCESS

Genie is a registered trademark of Genie Lift Corporation. © 2016 Genie Lift Corporation. All rights reserved.

- 1 Select "Customer Login" to login or select "Request New Access" to create a new account.
- 2 At the homepage, select "Unit Configuration" and enter your machine serial number.
- 3 Press the "Lookup" button to view your machine configuration and to check for open bulletins.
- 4 Complete all required bulletins shown for your specific machine serial number.

#### Machines purchased in Europe, Middle East, Africa, and Russia:

Go to [EMEAR Bulletins](http://www.genielift.co.uk/en/sales-and-support/bulletin-campaigns/index.htm)  
(<http://www.genielift.co.uk/en/sales-and-support/bulletin-campaigns/index.htm>)



- 1 Enter your machine serial number and press search to check for open bulletins.
- 2 Complete all required bulletins shown for your specific machine serial number.

## Quarterly Maintenance Procedures

### Q-2 Battery Inspection



Genie specifications require that this procedure be performed quarterly.

Proper battery condition is essential to good engine and machine performance and operational safety. Improper fluid levels or damaged cables and connections can result in engine and component damage and hazardous conditions.

**⚠ WARNING** Electrocutation/burn hazard. Contact with electrically charged circuits could result in death or serious injury. Remove all rings, watches and other jewelry.

**⚠ WARNING** Bodily injury hazard. Batteries contain acid. Avoid spilling or contacting battery acid. Neutralize battery acid spills with baking soda and water.

Note: Fully charge the batteries and allow the batteries to rest 24 hours before performing this procedure to allow the battery cells to equalize.

- 1 Be sure that the battery cable connections are free of corrosion.

Note: Adding terminal protectors and a corrosion preventative sealant will help eliminate corrosion on the battery terminals and cables.

- 2 Be sure that the battery retainers and cable connections are tight.
- 3 Be sure that the battery separator wire connections are tight (if equipped).

#### Models without maintenance-free or sealed batteries:

- 4 Put on protective clothing and eye wear.
- 5 Remove the battery vent caps and check the specific gravity of each battery cell with a hydrometer. Note the results.
- 6 Check the ambient air temperature and adjust the specific gravity reading for each cell as follows:
  - Add 0.004 to the reading of each cell for every 10° F / 5.5° C above 80° F / 26.7° C.
  - Subtract 0.004 from the reading of each cell for every 10° F / 5.5° C below 80° F / 26.7° C.
- ⊙ Result: All battery cells display an adjusted specific gravity of 1.277 or higher. The battery is fully charged. Proceed to step 10.
- ⊗ Result: One or more battery cells display a specific gravity of 1.276 or below. Proceed to step 7.
- 7 Perform an equalizing charge OR fully charge the battery(s) and allow the battery(s) to rest at least 6 hours.
- 8 Remove the battery vent caps and check the specific gravity of each battery cell with a hydrometer. Note the results.

## Quarterly Maintenance Procedures

- 9 Check the ambient air temperature and adjust the specific gravity reading for each cell as follows:
- Add 0.004 to the reading of each cell for every 10° F / 5.5° C above 80° F / 26.7° C.
  - Subtract 0.004 from the reading of each cell for every 10° F / 5.5° C below 80° F / 26.7° C.
- ⊙ Result: All battery cells display a specific gravity of 1.277 or greater. The battery is fully charged. Proceed to step 10.
- ⊗ Result: One or more battery cells display a specific gravity from 1.218 to 1.269. The battery is still usable, but at a lower performance. The battery will need to be recharged more often. Proceed to step 10.
- ⊗ Result: One or more battery cells display a specific gravity from 1.217 to 1.173. The battery is approaching the end of its life. Proceed to step 10.
- ⊗ Result: The difference in specific gravity readings between cells is greater than 0.1 OR the specific gravity of one or more cells is less than 1.177. Replace the battery.
- 10 Check the battery acid level. If needed, replenish with distilled water to 1/8 inch / 3 mm below the bottom of the battery fill tube. Do not overfill.
- 11 Install the vent caps and neutralize any electrolyte that may have spilled.

### Q-3

## Inspect the Electrical Wiring



Genie specifications require that this procedure be performed quarterly.

Maintaining electrical wiring in good condition is essential to safe operation and good machine performance. Failure to find and replace burnt, chafed, corroded or pinched wires could result in unsafe operating conditions and may cause component damage.

### **⚠ WARNING**

Electrocution/burn hazard. Contact with electrically charged circuits could result in death or serious injury. Remove all rings, watches and other jewelry.

- 1 Inspect the following areas for burnt, chafed, corroded and loose wires:
  - Inside of the operator's compartment
  - Underside of the chassis
  - Inside engine compartment
- 2 Inspect for a lite, even coating of dielectric grease in the following locations:
  - All harness connectors

Note: Do not apply excessive amounts of dielectric grease to harness connectors, pins or sockets.

Note: Do not apply dielectric grease to a engine ECU/ECM or engine harness connectors.

- 3 Start the engine and raise the boom so there is enough room to access and remove all the covers attached to the chassis.
- 4 Attach a lifting strap from an overhead crane to the boom. Support the boom. Do not apply any lifting pressure.

## Quarterly Maintenance Procedures

- 5 Remove all engine covers, hydraulic tank covers and chassis covers.

### **⚠ DANGER**

Crushing hazard. Death or serious injury could result if the boom should unexpectedly fall while working underneath the boom. Do not stand or work beneath a boom that is not properly supported.

- 6 Inspect the following areas for burnt, chafed, corroded, pinched and loose wires:
- Engine
  - Transmission
  - Manifolds
  - Chassis
- 7 Inspect for a lite, even coating of dielectric grease in all connections between the transmission and the operator's compartment.

Note: Do not apply excessive amounts of dielectric grease to harness connectors, pins or sockets.

Note: Do not apply dielectric grease to a engine ECU/ECM or engine harness connectors.

- 8 Install all covers removed in step 5.
- 9 Remove the lifting strap from the overhead crane.
- 10 Start the engine and lower the boom to the stowed position. Turn the machine off.

### Q-4

### Check the Boom Wear Pads



Genie specifications require that this procedure be performed quarterly.

#### GTH-636, GTH-844, GTH-1056

- 1 Extend the boom until the wear pads are accessible.

Note: It may be necessary to remove the wear pad retainer plates to expose the wear pads.

- 2 Inspect the end of each upper wear pad.

- ⊙ Result: The wear pad grooves are visible on the end of the wear pad.
- ⊗ Result: The grooves on the end of the wear pad are no longer visible. Replace both wear pads. Refer to the appropriate Service and Repair Manual for repair procedure, *How to Replace the Boom Wear Pads*.

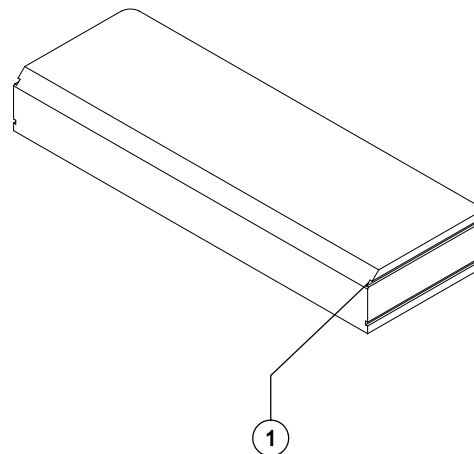

1 wear pad groove

# Quarterly Maintenance Procedures

- 3 Repeat the procedure for the lower wear pads.
- 4 Measure each side wear pad.
  - ⊙ Result: The measurement is within specification.
  - ⊗ Result: The measurement is less than specification. Replace all side wear pads. Refer to the appropriate Service and Repair Manual for repair procedure, *How to Replace the Boom Wear Pads*.

---

### Boom Wear Pad Specifications

---

Side wear pad thickness, minimum	3/8 inch 9.5 mm
----------------------------------	--------------------

---

### GTH-1256, GTH-1544 and GTH-5519

- 1 Extend the boom until the wear pads are accessible.
- 2 Inspect each pad and ensure that the pad thickness is more than 0.04 inches / 1 mm (see figure).
  - ⊙ Result: If thickness is above 0.04 inches / 1 mm, the pad can be re-used.

Result: if thickness is less than 0.04 inches / 1 mm, replace the worn pad. Refer to the appropriate Service and Repair Manual for repair procedure, *How to Replace the Boom Wear Pads*.

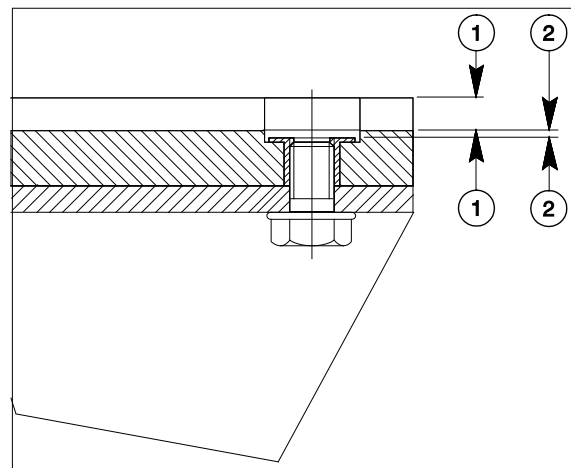

- 1 Maximum wearing thickness
- 2 Minimum wearing thickness

---

### Boom Wear Pad Screws Tightening Specifications

---

Screws M10	22 ft-lbs 30 Nm
------------	--------------------

---



## Quarterly Maintenance Procedures

### Q-5 Check the Exhaust System

Genie specifications require that this procedure be performed quarterly.

Maintaining the exhaust system is essential to good engine performance and service life. Operating the engine with a damaged or leaking exhaust system can cause component damage and unsafe operating conditions.

**⚠ WARNING** Bodily injury hazard. Do not inspect while the engine is running. Remove the key to secure from operation.

**⚠ CAUTION** Burn hazard. Beware of hot engine components. Contact with hot engine components may result in severe burns.

- 1 Be sure that all nuts and bolts are tight.
- 2 Inspect all welds for cracks.
- 3 Inspect for exhaust leaks; i.e., carbon buildup around seams and joints.

### Q-6 Inspect the Tires, Wheels and Lug Nut Torque



Genie specifications require that this procedure be performed quarterly.

Maintaining the tires and wheels, including proper wheel fastener torque, is essential to safe operation and good performance. Tire and/or wheel failure could result in a machine tip-over. Component damage may also result if problems are not discovered and repaired in a timely fashion.

**⚠ WARNING** Bodily injury hazard. An over-inflated tire can explode and could cause death or serious injury.

**⚠ WARNING** Tip-over hazard. Do not use temporary flat tire repair products.

Note: The tires on some machines are foam-filled or solid rubber and do not need air added to them.

- 1 Check all tire treads and sidewalls for cuts, cracks, punctures and unusual wear.
- 2 Check each wheel for damage, bends and cracked welds.
- 3 Check each lug nut for proper torque. Refer to Specifications, *Machine Specifications*.
- 4 Check the pressure in each air-filled tire.

## Quarterly Maintenance Procedures

### Q-7 Inspect the Fork Level and Auxiliary Hydraulic Hoses Tension



Genie specifications require that this procedure be performed quarterly.

- 1 Fully retract the boom.
  - 2 Fully lower the tips of the lifting forks.
  - 3 Remove the cover from the fork end of the boom.
  - 4 Inspect the fork level and/or auxiliary hydraulic hoses for proper tension. Each hose should have the same amount of droop and should not rest on the boom tube.
- ☒ Result: The hose/s rest on the boom tube or have an unequal amount of droop. Refer to the appropriate Service and Repair Manual for repair procedure, *How to Adjust the Fork Level and Auxiliary Hydraulic Hose Tension*.

### Q-8 Inspect the Fuel and Hydraulic Tank Cap Venting Systems



Genie specifications require that this procedure be performed quarterly.

Perform this procedure more often if dusty conditions exist.

Free-breathing fuel and hydraulic tank caps are essential for good machine performance and service life. A dirty or clogged tank cap may cause the machine to perform poorly and continued use may cause component damage. Extremely dirty conditions may require that the caps be inspected more often.

#### **⚠ DANGER**

Explosion and fire hazard. Engine fuels are combustible. Perform this procedure in an open, well-ventilated area away from heaters, sparks, flames and lighted tobacco. Always have an approved fire extinguisher within easy reach.

Note: Perform this procedure with the engine off.

#### **GTH-636 and GTH-844**

- 1 Identify the vent tube breather from the fuel tank under the chassis center cover.
- 2 Check for proper venting.
  - ⦿ Result: Air passes through the vent tube. Proceed to **Hydraulic Tank Breather Cap**.
  - ☒ Result: If air does not pass through the vent tube, clean or replace the tube. Proceed to step 3.

Note: When checking for positive tank cap venting, air should pass freely through the tube.

- 3 Using a mild solvent, carefully wash the tube venting system. Dry using low pressure compressed air. Repeat this procedure beginning with step 2.

## Quarterly Maintenance Procedures

### GTH-1056, GTH-1256, GTH-1544 and GTH-5519:

- 1 Remove the fuel filler cap from the tank.
- 2 Check for proper venting.
- ⦿ Result: Air passes through the fuel tank cap. Proceed to step 4.
- ⊗ Result: If air does not pass through the cap, clean or replace the cap. Proceed to step 3.

Note: When checking for positive tank cap venting, air should pass freely through the cap.

- 3 Using a mild solvent, carefully wash the cap venting system. Dry using low pressure compressed air. Repeat this procedure beginning with step 2.
- 4 Install the fuel tank cap onto the fuel tank.

### Hydraulic Tank Breather Cap - All Models

- 1 Remove the breather cap from the hydraulic tank.
- 2 Check for proper venting. The cap is pressurized to 3 psi.
- ⦿ Result: Air passes through the breather cap. Proceed to step 4.
- ⊗ Result: If air does not pass through the cap, clean or replace the cap. Proceed to step 3.

Note: When checking for positive tank cap venting, air should pass freely through the cap.

- 3 Using a mild solvent, carefully wash the cap venting system. Dry using low pressure compressed air. Repeat this procedure beginning with step 2.
- 4 Install the breather cap onto the hydraulic tank.

## Quarterly Maintenance Procedures

### Q-9

### Visual Inspection of the Hydraulic Oil



Genie specifications require that this procedure be performed quarterly.

Replacement or testing of the hydraulic oil is essential for good machine performance and service life. Dirty oil and a clogged suction strainer may cause the machine to perform poorly and continued use may cause component damage. Extremely dirty conditions may require oil changes to be performed more often. For hydraulic oil specifications, Refer to Specifications, *Hydraulic Specifications*.

Note: Before replacing the hydraulic oil, the oil may be tested by an oil distributor for specific levels of contamination to verify that changing the oil is necessary. Replace the oil when it fails the test. Refer to Maintenance Procedure, *Test or Replace the Hydraulic Oil*.

- 1 Collect a sample of hydraulic oil and place in a clear container. Visually inspect the hydraulic oil for the following:
  - Color: oil should be a clear, light-honey colored
  - Appearance, oil should be clear and not cloudy or visibly distorts the view through the sight glass or container
  - Contains no particles, foreign objects, or other contamination
  - The hydraulic oil can be inspected by smell (can smell "hot" but not "burnt") or rubbing between fingers (should feel viscous and free of any rough feel due to particles)
- ⦿ If the hydraulic oil passes all of the above inspections, continue the scheduled maintenance intervals.
- ✗ If the hydraulic oil fails any of the above inspections, the hydraulic oil must be tested by an oil distributor or replaced.

Note: If the hydraulic oil was not replaced at or before the 2000 hour maintenance interval, the oil must be tested every quarter by an oil distributor until the oil fails the test and is replaced. After the oil has been replaced, continue the scheduled quarterly maintenance inspection.

Note: When replacing the hydraulic oil, it is recommended that all hydraulic filters be replaced at the same time.

## Quarterly Maintenance Procedures

### Q-10 Inspect the Engine Air Filter



Genie specifications require that this procedure be performed quarterly.

Perform this procedure more often if dusty conditions exist.

Maintaining the engine air filter in good condition is essential to good engine performance and service life. Failure to perform this procedure can lead to poor engine performance and component damage.

Note: Perform this procedure with the engine off.

- 1 Release the latches on the cover of the air cleaner assembly. Remove the cover.
- 2 Gently twist and pull out the external or primary filter element.
- 3 Remove the inner or secondary filter element.
- 4 Clean the inside of the canister and the gasket with a damp cloth.
- 5 Inspect the primary and secondary air filter elements. If needed, blow from the inside out using low pressure dry compressed air, or carefully tap out dust.
- 6 Install the secondary filter element first, then install the primary filter element.
- 7 Install the front cover onto the air cleaner assembly and secure the latches.

### Q-11 Lubricate the Driveshaft



Genie specifications require that this procedure be performed quarterly.

Greasing the specified locations is essential for good machine performance and service life. Operating the machine with little or no grease may cause the machine to perform poorly and continued use may cause component damage.

- 1 Using a grease gun, thoroughly grease each driveshaft, at both ends of the driveshaft.

---

#### Grease Specifications

---

Chevron Ultra-duty grease, EP NLGI 2 (lithium based) or equivalent

---

## Quarterly Maintenance Procedures

### Q-12 Inspect and Lubricate the Sequencing Chains - GTH-636, GTH-1256, GTH-1544, GTH-844 and GTH-1056



Genie specifications require that this procedure be performed quarterly.

In extremely dusty or hostile environments, it may be necessary to lubricate the chains more often.

Maintaining the sequencing chains in good condition is essential to safe operation and good machine performance. Failure to detect damage to the chains could result in a hazardous operating condition.

Environments in which Genie Telehandlers operate can vary widely from outdoor moisture and temperature extremes, to mildly corrosive or highly corrosive industrial atmospheres, in addition to abrasive exposures such as sand and grit.

In addition, dynamic shock loading can impose abnormal loads above the endurance limit of the chains. Examples of dynamic shock loading are:

- High velocity movement of load, followed by sudden abrupt stops.
- Carrying loads in suspension over irregular surfaces and rough terrain.
- Attempting to "inch" loads which are beyond the rated capacity of the vehicle.

The load cycles and environmental conditions make it impossible to predict chain life. It is therefore necessary to conduct regular inspections.

- 1 Park the machine on a firm level surface, level the boom and engage the parking brake.
- 2 Fully extend the boom.
- 3 Inspect the chains for the following conditions:

#### **GTH-636, GTH-844 and GTH-1056 models**

- Elongation
- BL666 chain - Measure 16 pitches of the extend chain for machines using BL666 chain.

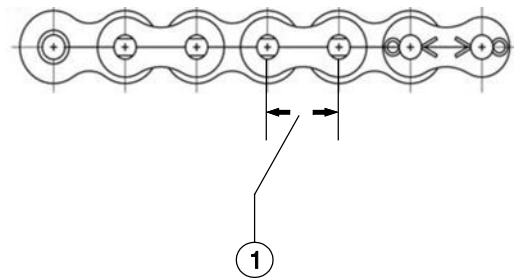

1 chain pitch

Note: For identification, this chain typically measures 3/4 inch between pin centers when new.

Note: Both the extend and retract chains should be measured.

Note: Measurement should be taken in the area where the chain articulates most frequently over the sheaves.

- Result: The distance measures 12.36 inches / 313mm or less. The chain is within specifications. Continue with inspection.
- ✗ Result: If the distance is greater than 12.36 inches / 313mm, the machine shall be removed from service until the chain is replaced.

Note: The boom chain's normal life expectancy can be expressed as a maximum percent of elongation of 3%.

## Quarterly Maintenance Procedures

### GTH-1256 and GTH-1544 models

- Elongation

Note: The pitch of the boom extend chains (boom lower section) shall be 1 inch / 25.4 mm.

Note: The pitch of the boom retract chains (boom upper section) shall be 0.75 inches / 19.05 mm.

**GTH-1256:** Only the extend chains should be measured.

**GTH-1544:** Both the extend and retract chains should be measured.

Note: Measurement should be taken in the area where the chain articulates most frequently over the sheaves.

- ⊙ Result: The distance measures 1 inch / 25.4 mm (lower chain) or 0.75 inches / 19.05 mm (upper chain). The chain is within specification. Continue with inspection.
- ⊗ Result: The distance is greater than 1 inch / 25.4 mm (lower chain) or 0.75 inches / 19.05 mm. The machine shall be removed from service until the chain is replaced.

Note: The boom chain's normal life expectancy can be expressed as a maximum percent of elongation of 2%.

Note: Consult Product Support to know the correct procedure to better understand maximum percent of chain elongation.

### All models:

- **Edge wear:**

Check the chain for wear on the link plate edges caused by running back and forth over the sheave. The maximum reduction of material should not exceed 5%.

- **Cracked plates:**

Check link side plates for any cracks. These are generally a sign of chain fatigue.

- **Turning pins:**

Check the pins. The position of the riveting must be parallel with the top and bottom of the side plate.

If any of these conditions are discovered during the inspection, the chain must be replaced.

After inspection and before being returned to service, the chains must be lubricated with a quality chain lubricant.

Note: Do not use grease to lubricate chains.

The chain plates should be brushed with a wire brush prior to lubrication to clear the space between the plates.

The lubricant must penetrate the chain joint to prevent wear. Applying lubricant to the external surfaces will prevent rust, but the chains should be articulated to make sure the lubricant penetrates to the working surfaces between the pins and links.

Lubricant may be applied with a brush, sprayed or poured on, but the chain should be well flooded with lubricant and the boom should be extended and retracted to insure that the lubricant penetrates all working surfaces. All excess lubricant should be wiped away from the external surfaces.

Note: Do not use solvents to remove excess lubricant.

# Annual Maintenance Procedures

## A-1 Inspect the Forks



Genie specifications require that this procedure be performed annually. OR whenever permanent deformation of the forks is suspected.

Maintaining the lifting forks in good condition is essential to safe operation and good machine performance. Failure to detect damage to the forks could result in a hazardous operating condition.

- 1 Thoroughly clean the lifting forks.
- 2 Inspect the forks for the following:
  - Surface cracks
  - Straightness of the blade and shank
  - Fork angle at  $90 \pm 3$  degrees
  - Relative height of fork tips shall not differ more than 3% of blade length

Fork	3% of blade length
48" forks	1.44 in
60" forks	1.8 in
72" forks	2.16 in

- Excessive wear to the forks, fork mount or legible markings

⊗ Result: If any of the above criteria are not met, the fork must be removed from service until it is repaired or replaced.



1 shank  
2 blade

## A-2 Adjust the Boom Sequencing Chains - GTH-636 and GTH-844



Genie specifications require that this procedure be performed annually.

- 1 Raise the boom to the horizontal position.
- 2 Extend the boom fully, then retract the boom approximately 1 inch / 25 mm.
- 3 On either side of the middle boom section, estimate the center. Place one end of a tape measure on the top surface of the boom directly above the estimated center.
- 4 Select a reference point on the sequencing chain. Measure the distance between the chain and the top surface of the boom. Note the measurement (1). Refer to the following illustrations.

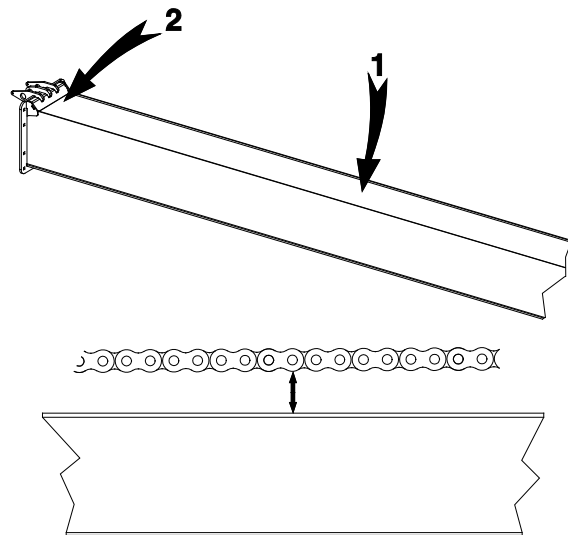



## Annual Maintenance Procedures

- 5 Move to the fork end of the same boom section that was just measured.
- 6 Measure the distance between the top surface of the boom and the same reference point used on the sequencing chain in step 4. Note the measurement (2).
- ⊙ Result: The difference between measurements 1 and 2 is 0.25 to 0.5 inch / 6.35 to 12.7 mm. No adjustment to the chain is necessary. Proceed to step 10.
- ⊗ Result: The difference between measurements 1 and 2 is less than a 0.25 inch / 6.35 mm OR is greater than 0.5 inch / 12.7 mm. The chain requires adjustment. Proceed to step 7.

Note: The measurements taken in step 4 and step 6 must be taken from the same plane on the boom.

- 7 Working at the fork end of the large boom tube, locate the adjustable chain anchor on the top of boom section.
- 8 Place an adjustable wrench across the flat part of the chain, just ahead of the chain anchor. Tighten the wrench onto the chain.
- 9 Using a 1 7/16 inch wrench, adjust the nut as required to tighten or loosen the chain. Repeat this procedure for each chain beginning with step 4.

### A-3

## Adjust the Boom Sequencing Chains - GTH-1056



Genie specifications require that this procedure be performed annually.

- 1 Raise the boom to the horizontal position.
- 2 Extend the boom fully, then retract the boom approximately 1 inch / 25 mm.
- 3 Tie a string line on each end of the chain, being sure to pull the string taut.
- 4 At the midpoint of the string, measure the distance between the string and the chain surface corresponding to the surface the string line is attached to.
- ⊙ Result: The distance is 0.25 to 0.5 inch / 6.35 to 12.7 mm. No adjustment to the chain is necessary. Proceed to step 8.
- ⊗ Result: The distance is less than a 0.25 inch / 6.35 mm OR is greater than 0.5 inch / 12.7 mm. The chain requires adjustment. Proceed to step 5.
- 5 Working at the fork end of the large boom tube, locate the adjustable chain anchor on the top of the boom section.

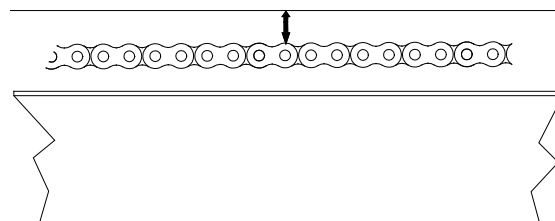

## Annual Maintenance Procedures

- 6 Place an adjustable wrench across the flat part of the chain, just ahead of the chain anchor. Tighten the wrench onto the chain.
- 7 Using a 1 7/16 inch wrench, adjust the nut as required to tighten or loosen the chain. Repeat this procedure beginning with step 4 until the gap is between 0.25 to 0.5 inch / 6.35 to 12.7 mm.

Note: If the adjusting bolt runs out of threads before the chain tension is correct, the chain has stretched too far and the chain must be replaced.

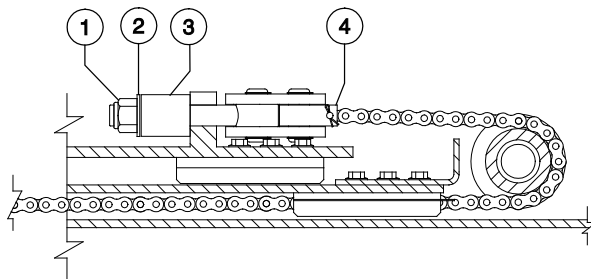

- 1 nut
- 2 washer
- 3 spacer
- 4 chain anchor

- 8 Fully retract the boom.
- 9 Measure the gap between the washer and the spacer. The gap should be between 0.125 to 0.25 inch / 3.2 mm to 6.35 mm.

### A-4

## Adjust the Boom Sequencing Chains - GTH-1256 and GTH-1544



Genie specifications require that this procedure be performed annually.

### Extend chains (boom bottom side)

- 1 Raise the boom to horizontal position.
- 2 Fully extend the boom.
- 3 Retract it about 3.9 inches / 100 mm.
- 4 Tighten the chain up to a maximum tension value of 37 ft-lbs / 50 Nm.
- 5 Check that all chains have been equally tensioned. If not, repeat the operation described above.
- 6 Lock the chain tensioners by means of a counternut and locknut.

### Retract chains (boom upper side)

- 1 Fully retract the boom.
- 2 Extend the boom by 11.8 inches / 300 mm.
- 3 Loosen the locker nut.
- 4 Tighten the tensioning nut to 37 ft-lbs / 50 Nm.
- 5 Tighten the locker nut.
- 6 Check that all chains have been equally tensioned. If not, repeat the operation described above.

Note: If during chain tensioning, problems are detected, please Genie Product Support.

## Annual Maintenance Procedures

### A-5 Replace Hydraulic Tank Return Filter Element



Genie specifications require that this procedure be performed annually.

Perform this procedure more often if dusty conditions exist.

Replacement of the hydraulic filters is essential for good machine performance and service life. A dirty or clogged filter may cause the machine to perform poorly and continued use may cause component damage. Extremely dirty conditions may require that the filter be replaced more often.

**CAUTION** Bodily injury hazard. Beware of hot oil. Contact with hot oil may cause severe burns.

Note: Perform this procedure with the engine off.

- 1 Locate the hydraulic tank return filter.

Note: Location and access may vary, depending on model.

- 2 Release the pressure in the oil reservoir by loosening the filler/breather cap.
- 3 Unscrew the return filter.
- 4 Install the new filter element.
- 5 Tighten the filler/breather cap.
- 6 Record the hours the filter element was replaced and keep with your maintenance records.
- 7 Start the engine.
- 8 Inspect the filter assembly to be sure that there are no leaks.
- 9 Clean up any oil that may have spilled during the installation procedure.

### A-6 Replace the Cab Air Intake Filter Element (if equipped)



Genie specifications require that this procedure be performed annually.

Perform this procedure more often if dusty conditions exist.

Note: Location of the air intake access cover will vary, depending on specific models.

- 1 Remove the fasteners securing the cab air intake access cover and remove the cover.
- 2 Remove the air intake filter element.
- 3 Install the new filter element.
- 4 Re-install the cab air intake access cover.

## Programmed Maintenance Procedures

### P0-1

#### Lubricate the Boom



Genie specifications require that this procedure be performed every 8 hours or daily, whichever comes first.

Greasing the specified locations is essential for good machine performance and service life. Operating the machine with little or no grease may cause the machine to perform poorly and continued use may cause component damage.

- 1 Fully extend and raise the boom, then retract the boom, checking to insure it operates smoothly. There should be a light film of lubricant on wear pad contact surfaces.
  - ⊙ Result: Boom operates smoothly and a thin film of lubricant is visible. Proceed to step 6.
  - ⊗ Result: Boom does not extend or retract smoothly and no lubricant is visible on wear pad contact surfaces. Proceed to step 2.
- 2 GTH-1056 and GTH-1256 proceed to step 3.  
GTH-844, GTH-636 and GTH-5519 proceed to step 4.
- 3 Apply a thin layer of grease to the underside of the number 4 boom tube where it makes contact with the number 3 boom tube lower wear pads.

- 4 Apply a thin layer of grease to the underside of the number 3 boom tube where it makes contact with the number 1 boom tube lower wear pads.
- 5 Lubricate the top and side boom tube wear pads.
- 6 Return the boom to the stowed position.

---

#### Grease specification

---

EP NLGI 2 (lithium based) or equivalent

---

Lube-A-Boom grease, 7 lb pail  
(recommended)

Genie part number 110147

---

Chevron Ultra-Duty EP 2 grease (alternate)

---

PTFE INTERFLON FIN GREASE LS 2

Genie part number 09.4693.0000

---

## Programmed Maintenance Procedures

### P0-2

### Deutz Engine Maintenance – Under 1000 Hours

Additional engine maintenance is required. Refer to the *Programmed Maintenance Inspection Report* for the specific intervals that apply.

Required maintenance procedures and additional engine information are available in the manufacturer's manuals. Refer to Specifications, *Engine Operator and Maintenance Manuals*.

This maintenance schedule applies to the following Deutz Engines:

**Deutz TD 2.9 L4**

**Deutz TCD 3.6 L4**

**Deutz TCD 4.1 L4**

Deutz Engines		Hour Intervals		
Procedure	∅ = Not required	Daily	250	500
Oil level - check			∅	∅
Coolant level - check			∅	∅
Oil, fuel and coolant systems - check for leaks			∅	∅
Fuel system filter/water separator – inspect/drain			∅	∅
Air filter discharge valve - clean			∅	∅
Engine tightness – check for leaks			∅	∅
Exhaust system - inspect			∅	∅
Fuel pre-cleaner / fuel pre-filter - clean		∅		∅
Cooling system- check		∅		∅
Engine oil and filter – replace		∅	∅	
Air filter - replace		∅	∅	
Valve clearance - check/adjust		∅	∅	
Engine coolant - test/add		∅	∅	
Air intake pipes - inspect		∅	∅	
V-belts - inspect		∅	∅	
Fuel filter / separator - replace		∅	∅	

## Programmed Maintenance Procedures

### P0-3

### Perkins Engine Maintenance – Under 1000 Hours

Additional engine maintenance is required. Refer to the *Programmed Maintenance Inspection Report* for the specific intervals that apply.

Required maintenance procedures and additional engine information are available in the manufacturer's manuals. Refer to Specifications, *Engine Operator and Maintenance Manuals*.

This maintenance schedule applies to the following Perkins Engines:

**Perkins 854E-E34TA    Perkins 1104D-E44TA    Perkins 1204E-E44TA**

Perkins Engine		Hour Intervals		
Procedure	∅ = Not required	Daily	50	500
Oil level - check			∅	∅
Coolant level – check/add			∅	∅
Oil, fuel and coolant systems - check for leaks			∅	∅
Air filter discharge valve - clean			∅	∅
Fuel system filter/water separator – drain			∅	∅
Alternator belt - inspect/adjust/replace			∅	∅
V-belts - inspect/adjust/replace			∅	∅
Exhaust system - check for leaks			∅	∅
Fuel tank water/sediment - drain		∅		∅
Hoses and clamps – inspect/replace		∅		∅
Engine valve lash – inspect/adjust - 1104D-E44TA Models (initial one time service)		∅	∅	
Battery electrolyte level - check		∅	∅	
Cooling system supplement additive - test/add		∅	∅	
Engine oil and filter – replace		∅	∅	
Fuel system filter(s) - replace		∅	∅	
Radiator – clean		∅	∅	
Air cleaner element - clean/replace		∅	∅	
Fan clearance - check		∅	∅	

## Programmed Maintenance Procedures

### P0-4

#### John Deere Engine Maintenance – Under 1000 Hours

Additional engine maintenance is required. Refer to the *Programmed Maintenance Inspection Report* for the specific intervals that apply.

Required maintenance procedures and additional engine information are available in the manufacturer's manuals. Refer to Specifications, *Engine Operator and Maintenance Manuals*.

John Deere 4045TH485		Hour Intervals	
Procedure	∅ = Not required	Daily	500
Oil level - check			∅
Coolant level – check/add			∅
Fuel system filter/water separator – drain			∅
Air filter discharge valve - clean			∅
Oil, fuel and coolant systems - check for leaks			∅
Air cleaner - check			∅
Visual inspection of engine			∅
Engine oil - replace		∅	
Oil filter - replace		∅	
Engine mounts - inspect		∅	
Battery - check		∅	
Crankcase vent system - check		∅	
Air intake system - inspect		∅	
Cooling system - check		∅	
Engine ground - check		∅	
Air filter - replace		∅	
Engine belts - check/adjust/replace		∅	
Fuel system - check		∅	
Fuel filter - replace		∅	

## Programmed Maintenance Procedures

### P0-5

#### Axle Maintenance – Under 1000 Hours

Additional axle maintenance is required. Refer to the *Programmed Maintenance Inspection Report* for the specific intervals that apply.

Required maintenance procedures and additional transmission information are available in the manufacturer's manuals. Refer to Specifications, *Operator and Maintenance Manuals*.

<b>Carraro 26.27M Axle</b>		<b>Hour Intervals</b>		
<b>Procedure</b>	<b>∅ = Not required</b>	<b>50</b>	<b>150</b>	<b>300</b>
Oil level - check/add (initial, one-time interval)			∅	∅
Axle oil - change (initial, one-time interval)		∅		∅
Clean magnetic oil plugs (initial, one-time interval)		∅		∅
Oil breather - clean (initial, one-time interval)		∅		∅
Grease axle (initial, one-time interval)		∅		∅
Oil level - check/add		∅	∅	
Oil breather - clean		∅	∅	

<b>Comer Axle</b>		<b>Hour Intervals</b>		
<b>Procedure</b>	<b>∅ = Not required</b>	<b>100</b>	<b>200</b>	<b>300</b>
Differential lubricating oil - check/add (initial, one-time interval)			∅	∅
Planetary reduction lubricating oil - check/add (initial, one-time interval)			∅	∅
Differential lubricating oil - change (initial, one-time interval)		∅		∅
Planetary reduction lubricating oil - change (initial, one-time interval)		∅		∅
Magnetic plug - clean (initial, one-time interval)		∅		∅
Axle - grease		∅		∅
Differential lubricating oil - check/add		∅	∅	
Planetary reduction lubricating oil - check/add		∅	∅	
Oil breather - clean		∅	∅	



## Programmed Maintenance Procedures

Dana Axles		Hour Intervals					
Procedure	∅ = Not required	Weekly	Monthly	100	200	500	800
King pin bearings and bushings - grease (severe duty perform daily)			∅	∅	∅	∅	∅
Trunnion bushings - grease (severe duty perform daily)			∅	∅	∅	∅	∅
Differential oil level - check		∅		∅	∅	∅	∅
Differential oil - change (initial, one-time interval)		∅	∅		∅	∅	∅
Hub oil - change (initial, one-time interval)		∅	∅		∅	∅	∅
Differential lubricating oil - change (initial, one-time interval)		∅	∅		∅	∅	∅
Planetary reduction lubricating oil - change (initial, one-time interval)		∅	∅		∅	∅	∅
Negative brake - adjust (initial, one-time interval)		∅	∅		∅	∅	∅
Hub oil - Check		∅	∅	∅		∅	∅
Planetary reduction lubricating oil - check/add		∅	∅	∅		∅	∅
Service brake - adjust		∅	∅	∅	∅		∅
Differential oil - change		∅	∅	∅	∅	∅	
Differential lubricating oil - change		∅	∅	∅	∅	∅	

## Programmed Maintenance Procedures

### P0-6

#### Transmission Maintenance – Under 1000 Hours

Additional transmission maintenance is required. Refer to the *Programmed Maintenance Inspection Report* for the specific intervals that apply.

Required maintenance procedures and additional transmission information are available in the manufacturer's manuals. Refer to Specifications, *Operator and Maintenance Manuals*.

This maintenance schedule applies to the following transmissions:

**Dana VDT12000 Dana TT20000 Dana Integral Gear Box Shift on Fly ZF 4 WG-98 TC**

Transmissions		Hour Intervals	
Procedure	Ø = Not required	Daily	100
Transmission oil level - check/add*			Ø
Drop box oil level - check/add			Ø
Transmission filter - replace (initial, one-time interval)		Ø	
Transmission oil - replace (initial, one-time interval)		Ø	

\*check oil with engine running at idle and oil at 180-200° F / 65-93° C

## Programmed Maintenance Procedures

### P1-1 Perform Engine Maintenance – 1000 Hours



Engine specifications require that this procedure be performed every 1000 hours.

Required maintenance procedures and additional engine information are available in the manufacturer's manuals. Refer to Specifications, *Engine Operator and Maintenance Manuals*.

#### Deutz Models

##### All Models:

- Charge air cooler entry area- drain lube oil/condensate
- Engine mounts- check
- Hose clamps and hoses- check
- V-rib belt and tensioning pulley- check
- Fuel filter cartridge - replace
- Fuel pre-filter - replace
- Filter insert for fuel pre-filter- replace
- Battery and cable connectors - check
- Cold starting device (if equipped) - check

#### Perkins Models

##### 854E-E34TA, 1204E-E44TA

- Water pump - inspect
- Engine crankcase breather element - replace

##### 1104D-E44TA

- Engine valve lash - inspect/adjust

### P1-2 Perform Transmission Maintenance – 1000 Hours



Transmission specifications require that this procedure be performed every 1000 hours.

Required maintenance procedures and additional axle information are available in the manufacturer's manuals. Refer to Specifications, *Operator and Maintenance Manuals*.

- Transmission oil and filter - replace
- Drop box (gearbox) - change oil

---

## Programmed Maintenance Procedures

### P1-3

### Perform Axle Maintenance – 1000 Hours



Axle specifications require that this procedure be performed every 1000 hours.

Required maintenance procedures and additional axle information are available in the manufacturer's manuals. Refer to Specifications, *Operator and Maintenance Manuals*.

#### Dana Models

- Negative brake - adjust
- Hub oil level - change
- Planetary reduction lubricating oil - change

#### Carraro 26.27M Models

- Change axle oil 1500 hrs
- Clean magnetic oil plugs 1500 hrs

#### Comer Models

- Differential lubricating oil - change
- Planetary reduction lubricating oil - change
- Magnetic plug - clean

## Programmed Maintenance Procedures

### P2-1

### Perform Engine Maintenance – 2000 Hours



Engine specifications require that this procedure be performed every 2000 hours.

Required maintenance procedures and additional engine information are available in the manufacturer's manuals. Refer to Specifications, *Engine Operator and Maintenance Manuals*.

#### Deutz Models

##### TCD 4.1 L4

- Valve clearance - setting
- V-belts - replace
- Exhaust gas recirculation, rods clearance - check/adjust
- Fuel pre-filter - replace
- Coolant - replace

#### Perkins Models

##### All models:

- Aftercooler core - inspect
- Engine mounts - inspect
- Starting motor - inspect
- Turbocharger - inspect

##### 1104D-E44TA

- Water pump - inspect
- Belt tensioner - inspect

##### 1104D-E44TA, 1204E-E44TA

- Alternator - inspect

#### John Deere

##### 4045TH485

- Thermostats - test
- Engine valve clearance check and adjust
- Cooling system - flush and refill

## Programmed Maintenance Procedures

### P2-2

#### Test or Replace the Hydraulic Oil



Genie requires that this procedure be performed every 2000 hours.

Replacement or testing of the hydraulic oil is essential for good machine performance and service life. Dirty oil and a clogged suction strainer or hydraulic filters may cause the machine to perform poorly and continued use may cause component damage. Extremely dirty conditions may require oil changes to be performed more frequently.

**Note:** Before replacing the hydraulic oil, the oil may be tested by an oil distributor for specific levels of contamination to verify that changing the oil is necessary. If the hydraulic oil is not replaced at the 2000 hour inspection, test the oil quarterly. Replace the oil when it fails the test.

**Note:** When removing a hose assembly or fitting, the O-ring (if equipped) on the fitting and/or hose end must be replaced. All connections must be torqued to specification during installation. Refer to Specifications, *Hydraulic Hose and Fitting Torque Specifications*.

#### Testing the oil:

- 1 Complete the hydraulic oil testing with an oil distributor.
- ⊙ If the hydraulic oil passes testing at the 2000 hour maintenance interval, the oil must be tested every quarter by an oil distributor until the oil fails the test and is replaced.
- ⊗ If the hydraulic oil fails testing at the 2000 hour maintenance interval, the oil must be replaced. After the oil has been replaced, continue the scheduled quarterly maintenance inspection.

#### Replacing the hydraulic oil:

- 1 Remove the drain plug from the hydraulic tank and completely drain the tank into a container of suitable capacity. Refer to Specifications, *Hydraulic Fluid Capacities Specifications*.
- 2 Fill the tank with the proper hydraulic oil for your machine. Refer to Specifications, *Hydraulic Specifications*.
- 3 **Engine Models:** Prime the pump. Refer to Repair Procedure in the appropriate Service and Repair Manual for your machine, *How to Prime the Pump*.
- 4 Clean up and properly dispose of any oil that may have spilled.

**Note:** When replacing the hydraulic oil, it is recommended that the hydraulic tank be cleaned using a mild solvent and all hydraulic filters and strainers be replaced.

**Note:** Always use pipe thread sealant when installing the suction hose fittings and the drain plug.

**Note:** After the oil has been replaced, continue the scheduled quarterly maintenance inspection.

## Programmed Maintenance Procedures

### P3-1 Perform Engine Maintenance – 3000 Hours



Engine specifications require that this procedure be performed every 3000 hours.

Required maintenance procedures and additional engine information are available in the manufacturer's manuals. Refer to Specifications, *Engine Operator and Maintenance Manuals*.

#### Deutz Models

##### TD 2.9 L4, TCD3.6 L4

- V-rib belt and tensioning pulley- replace

#### Perkins Models

##### All Models:

- Alternator Belt - Inspect/Adjust/Replace
- Cooling system coolant - change

##### 854E-E34TA

- Alternator - inspect
- Diesel Particulate Filter - clean
- Radiator Pressure Cap - clean/replace

##### 1204E-E44TA

- Radiator Pressure Cap - clean/replace
- Belt tensioner - inspect

### P4-1 Perform Engine Maintenance – 4000 Hours



Engine specifications require that this procedure be performed every 4000 hours.

Required maintenance procedures and additional engine information are available in the manufacturer's manuals. Refer to Specifications, *Engine Operator and Maintenance Manuals*.

#### Deutz Models

##### TCD 4.1 L4

- Flatter valve - replace
- V-rib belt and tensioning pulley - replace
- Spark plug of the DPF burner - replace

#### Perkins Models

##### All Models:

- Aftercooler Core - Clean/Test

#### John Deere 4045HF485 - 4500 Hours

- Crankshaft damper - replace

---

## Programmed Maintenance Procedures

### P6-1 Perform Engine Maintenance – 6000 Hours



Engine specifications require that this procedure be performed every 6,000 hours.

Required maintenance procedures and additional engine information are available in the manufacturer's manuals. Refer to Specifications, *Engine Operator and Maintenance Manuals*.

#### Deutz Models

##### TCD 4.1 L4

- Crankcase breather valve - replace

### P12-1 Perform Engine Maintenance – 12000 Hours



Engine specifications require that this procedure be performed every 12000 hours.

Required maintenance procedures and additional engine information are available in the manufacturer's manuals. Refer to Specifications, *Engine Operator and Maintenance Manuals*.

#### Perkins Models

##### 854E-E34TA, 1104D-E44TA, 1204E-E44TA

- Cooling System Coolant (Extended life coolant) - change



California Proposition 65



Operating, servicing and maintaining this equipment, passenger vehicle or off-highway motor vehicle can expose you to chemicals including engine exhaust, carbon monoxide, phthalates, and lead, which are known to the State of California to cause cancer and birth defects or other reproductive harm. These chemicals can be emitted from or contained in other various parts and systems, fluids and some component wear by-products. To minimize exposure, avoid breathing exhaust, do not idle the engine except as necessary, service your equipment and vehicle in a well-ventilated area and wear gloves or wash your hands frequently when servicing your equipment or vehicle and after operation. For more information go to [www.P65Warnings.ca.gov/passenger-vehicle](http://www.P65Warnings.ca.gov/passenger-vehicle).

Breathing diesel engine exhaust exposes you to chemicals known to the State of California to cause cancer and birth defects or other reproductive harm.

- Always start and operate the engine in a well-ventilated area.
- If in an enclosed area, vent the exhaust to the outside.
- Do not modify or tamper with the exhaust system.
- Do not idle the engine except as necessary.

For more information go to [www.P65warnings.ca.gov/diesel](http://www.P65warnings.ca.gov/diesel).